



VISADES
 Mauermannstrasse 2
 5023 Salzburg
 Tel.: 0662/871224-0
 Fax.: 0662/871224-10
 E-mail: office@visades.com

Device : T4500TCII Version 400V AC
 Cabinet : 800x1000x400
 Emitter : 3x5800W
 Version : Version 13

Manufacturer (company) : VISADES
 Path : Z:\EPLAN4\P\PLANE\EN\VD4500\
 Source : T4500_13

Changed on: 07. Dez. 2018 from (Abbreviation) ACA Number of pages 13

INTERN

EXTERN

		Date	07. Dez. 2018	T4500TCII Version 400V AC		Title page/ Titelblatt	Version 13	=	
		Appr.	ACA	800x1000x400				+	
		Contr.	Höllner	Source T4500_13			3x5800W		Sh 1
Changes	Date	Name		Date	19. Mär. 2013				11

INTERN

EXTERN

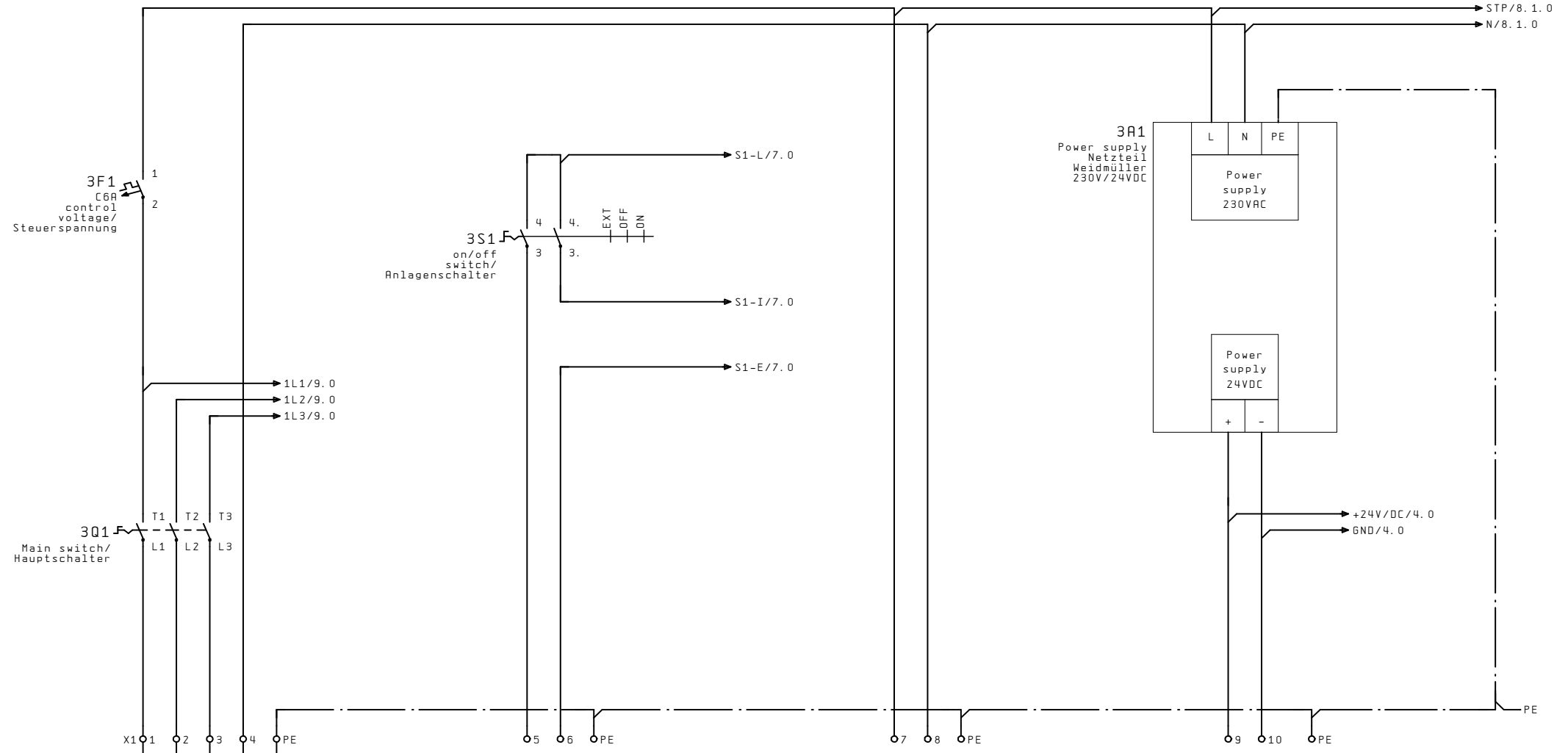

Power supply/
Versorgung
max. 5x16mm²
min. 32A

EXT. ON/OFF switch/
EXT. Anlagenschalter

Control voltage/
Steuerspannung
230VAC

Control voltage/
Steuerspannung
24VDC

Achtung auf elektromagnetische
Einstreuung, geschirmten Kabeltyp verwenden!

Attention on electromagnetic interference,
use shielded cable types!

No external supply!
Keine externe Versorgung!

		Datum	07. Dez. 2018	T4500TCII Version 400V AC 800x1000x400		Power supply/ Versorgung	Version 13	=		
		Bearb.	ACA				3x5800W	+		
		Gepr.	Höllner							S
Änderung	Datum	Name		Urspr.	T4500_13	DATUM	19. Mär. 2013		11	

4A1
Weidmüller
UR20-FBC-MOD

- PWR
- SF
- BF
- MT
- L/A X1
- L/A X2
-
-

Weidmüller
UR20-FBC-MOD
MODBUS TCP Fieldbus Coupler

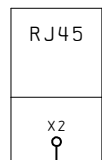
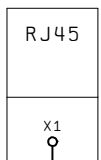
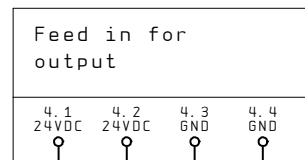
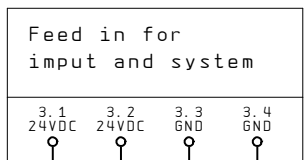

INTERN
3. 8/+24V/DC
3. 8/GND

+24V/DC/4. 1. 1
GND/4. 1. 1

CAT/4. 1. 1

PE

EXTERN

3		Datum 07. Dez. 2018		T4500TCII Version 400V AC			Weidmüller coupler		Version 13		=		
		Bearb. ACA		800x1000x400			UR20-FBC-MOD				+		
		Gepr. Höllner							3x5800W		s 4		
Änderung		Datum		Name		Urspr. T4500_13		DATUM 19. Mär. 2013				11	

Please refer to the Manual, 9.1.2 Ports of the Controller!

Bitte Handbuch Kapitel 9.1.2 Anschlüsse Controller beachten!

Visades User interface TCII

Display/Controller

4R1

Antenna
for optional
Modem

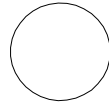

Antenne
Modem (opt.)

Visades 3.7V battery buffer

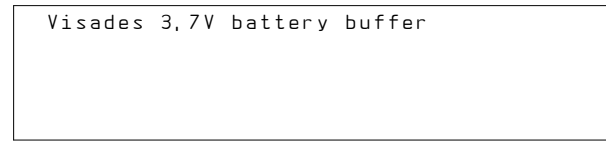

USB

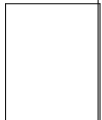

Micro SD

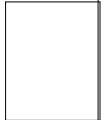

Micro SIM

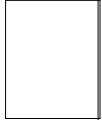

Termination resistor / Abschlusswiderstand



ON/Off Profibus DP

Modbus TCP
RJ45



Termination resistor / Abschlusswiderstand



ON/Off Modbus RTU

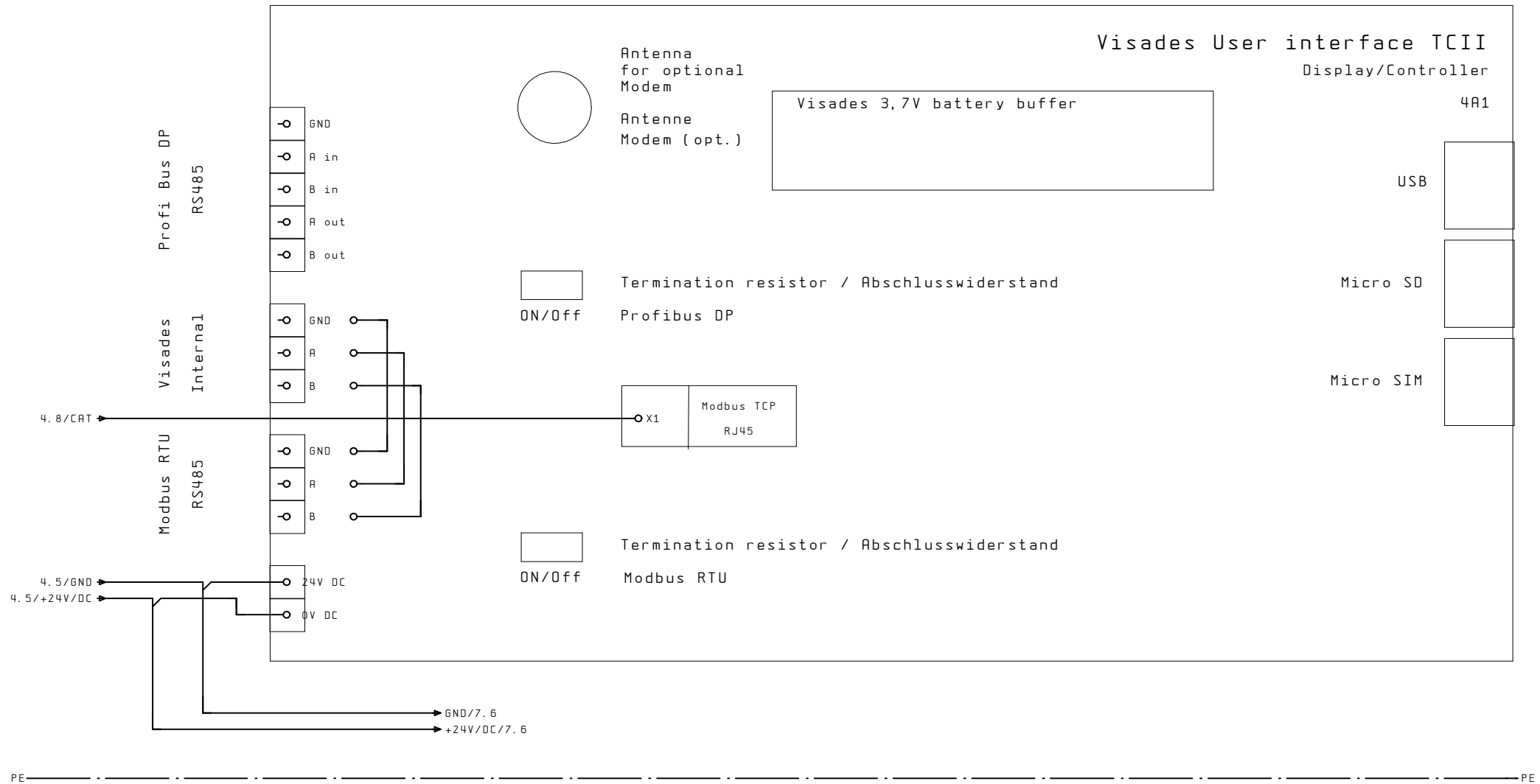

INTERN

EXTERN

4

5

		Datum	07. Dez. 2018	T4500TCII Version 400V AC 800x1000x400	VISADES	Display user interface	Version 13	=	
		Bearb.	ACA				+		
		Gepr.	Höllner						
Änderung	Datum	Name		Urspr.	T4500_13	DATUM	19. Mär. 2013	3x5800W	s 4.1

7R1
Weidmüller
UR20-8DI-P-2W

Weidmüller
UR20-8DI-P-2W
8 Digital Input, Source

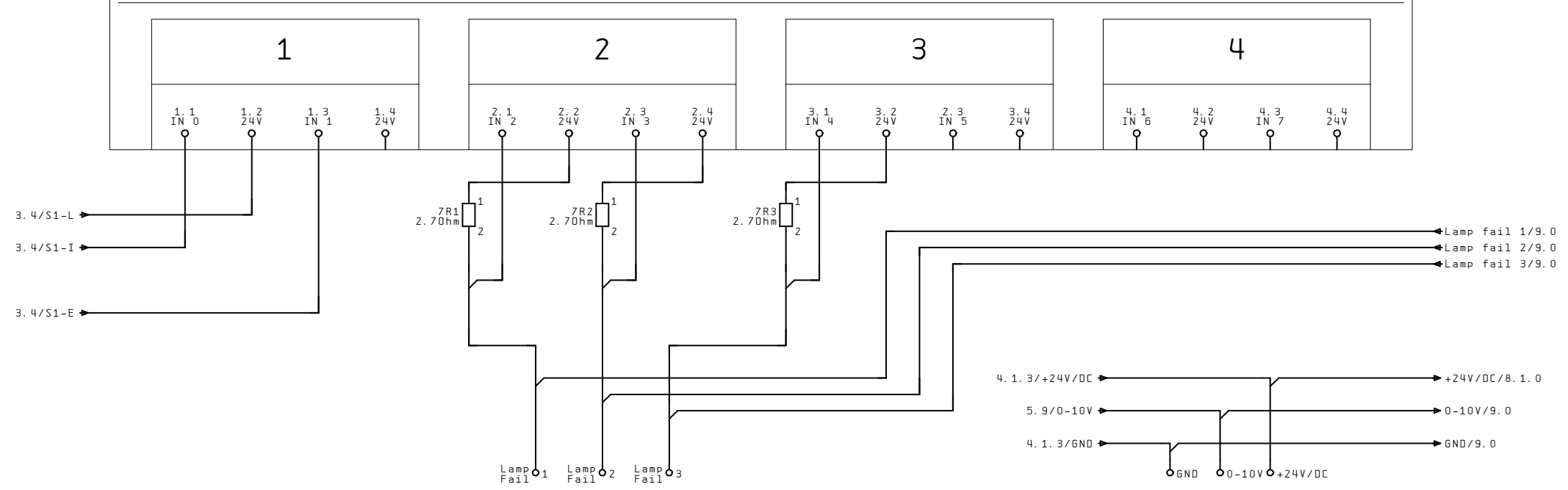

PE

1. 1/1. 2	1. 3/1. 4	2. 1/2. 2	2. 3/2. 4	3. 1/3. 2	3. 3/3. 4	4. 1/4. 2	4. 3/4. 4
ON	EXT	UV Lamp error / Lampenstörung	UV Lamp error / Lampenstörung	End pos. Main valve open/ Endlage Hauptvent. offen	End pos. Main valve close/ Endlage Hauptvent. geschl.	End pos. Flush valve open/ Endlage Spülventil offen	End pos. Flush valve close/ Endlage Spülventil geschl.

6 8

8A1
Weidmüller
UR20-4R0-CO-255

Weidmüller
UR20-4R0-CO-255
4 Relay Output Change Over

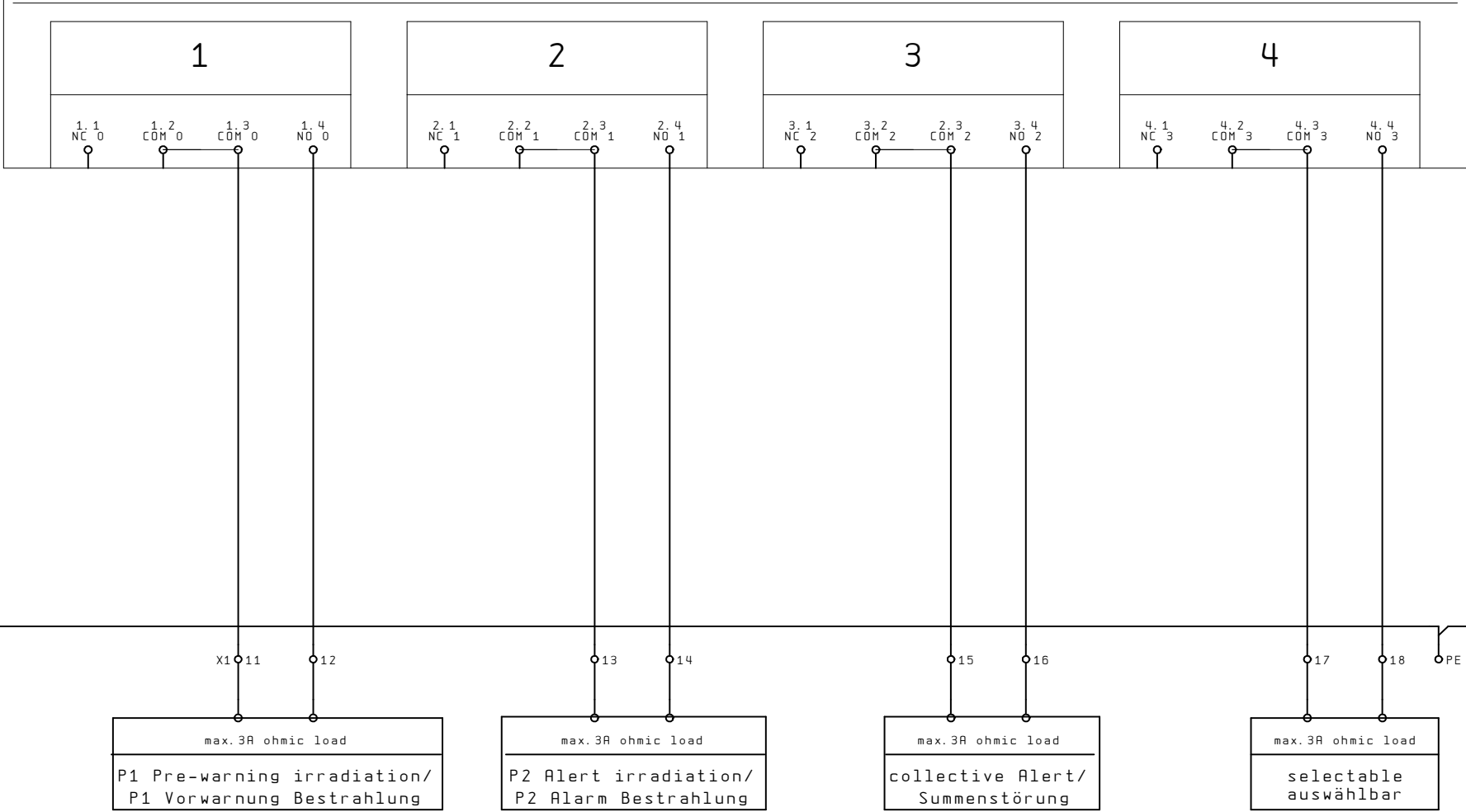

INTERN

EXTERN

Datum	07. Dez. 2018	T4500TCII Version 400V AC 800x1000x400		Weidmüller relay output UR20-4R0-CO-255	Version 13	=		
Bearb.	ACA					+		
Gepr.	Höllner							S
Änderung	Datum	Name	Urspr.	T4500_13	DATUM	19. Mär. 2013		
					3x5800W			

8A2
Weidmüller
UR20-4R0-CO-255

Weidmüller
UR20-4R0-CO-255
4 Relay Output Change Over

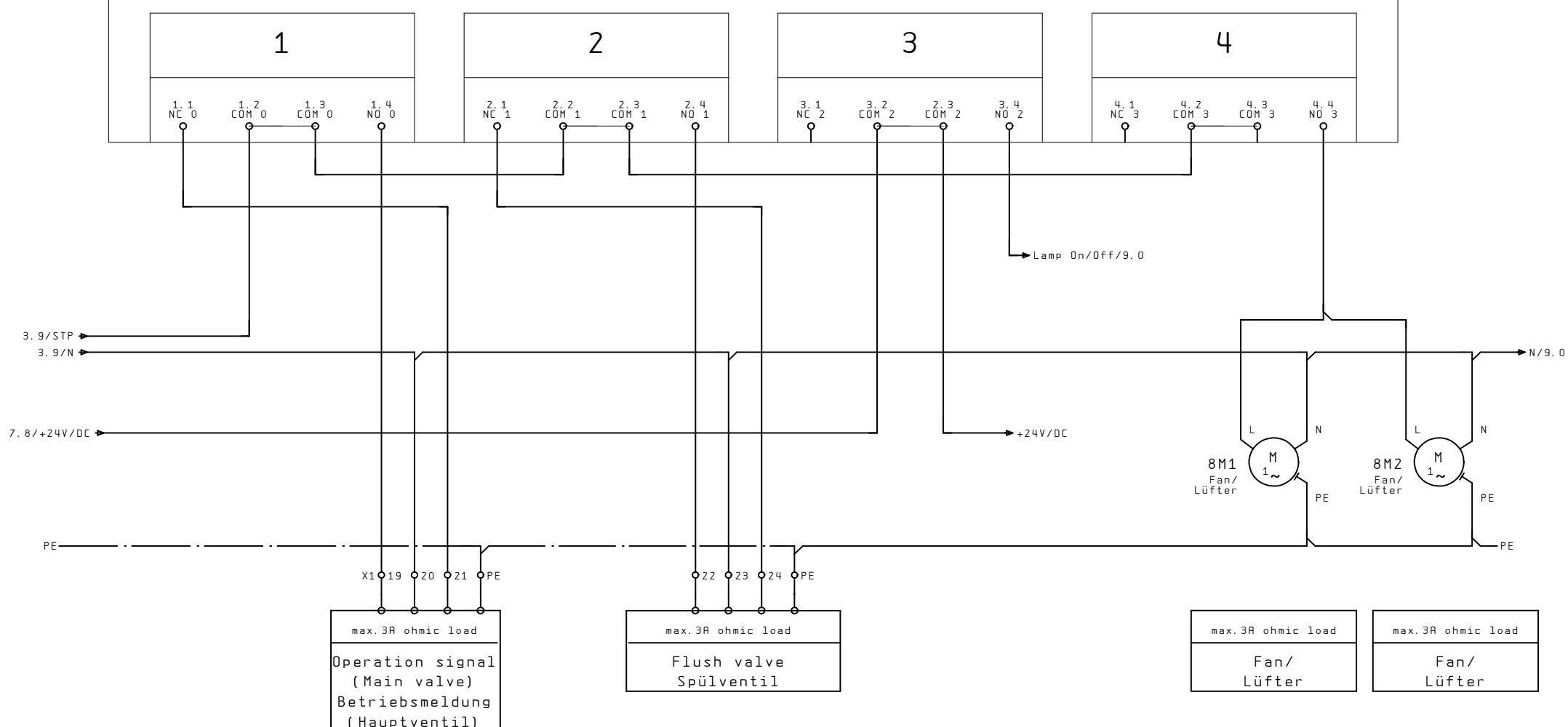

INTERN

EXTERN

8

9

Datum		07. Dez. 2018		T4500TCII Version 400V AC		Weidmüller relay output		Version 13		=	
Bearb.		ACA		800x1000x400		UR20-4R0-CO-255				+	
Gepr.		Höllner		Ursprr. T4500_13		DATUM 19. Mär. 2013		3x5800W		s 8.1	
Änderung		Datum		Name						11	



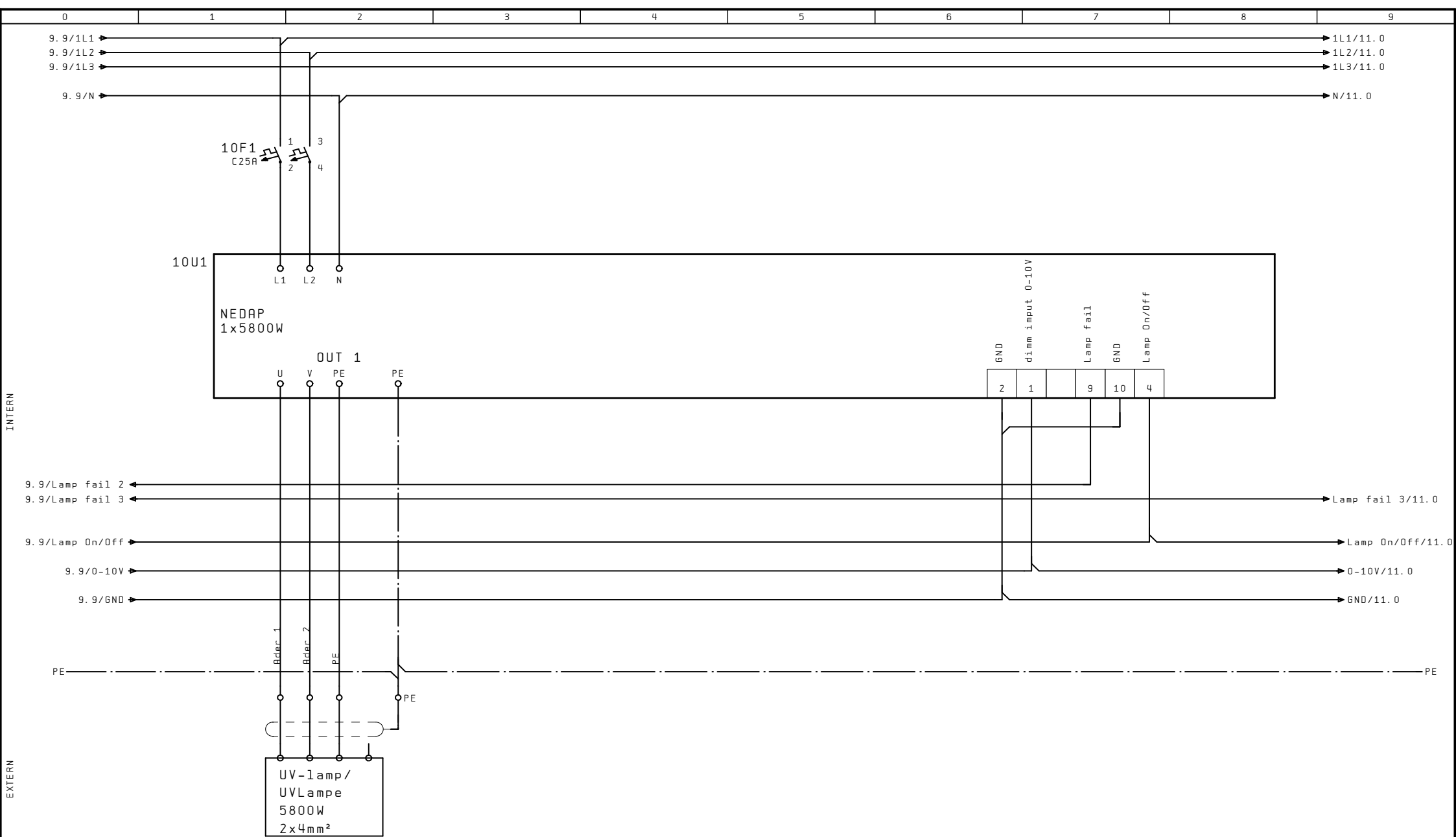

		Datum	07. Dez. 2018	T4500TCII Version 400V AC 800x1000x400		Ballast - UV-lamp / EVG - UV-Lampe		Version 13	=		
		Bearb.	ACA						+		
		Gepr.	Höllner					3x5800W			s
Händerung	Datum	Name		Urspr.	T4500_13	DATUM	19. Mär. 2013			11	

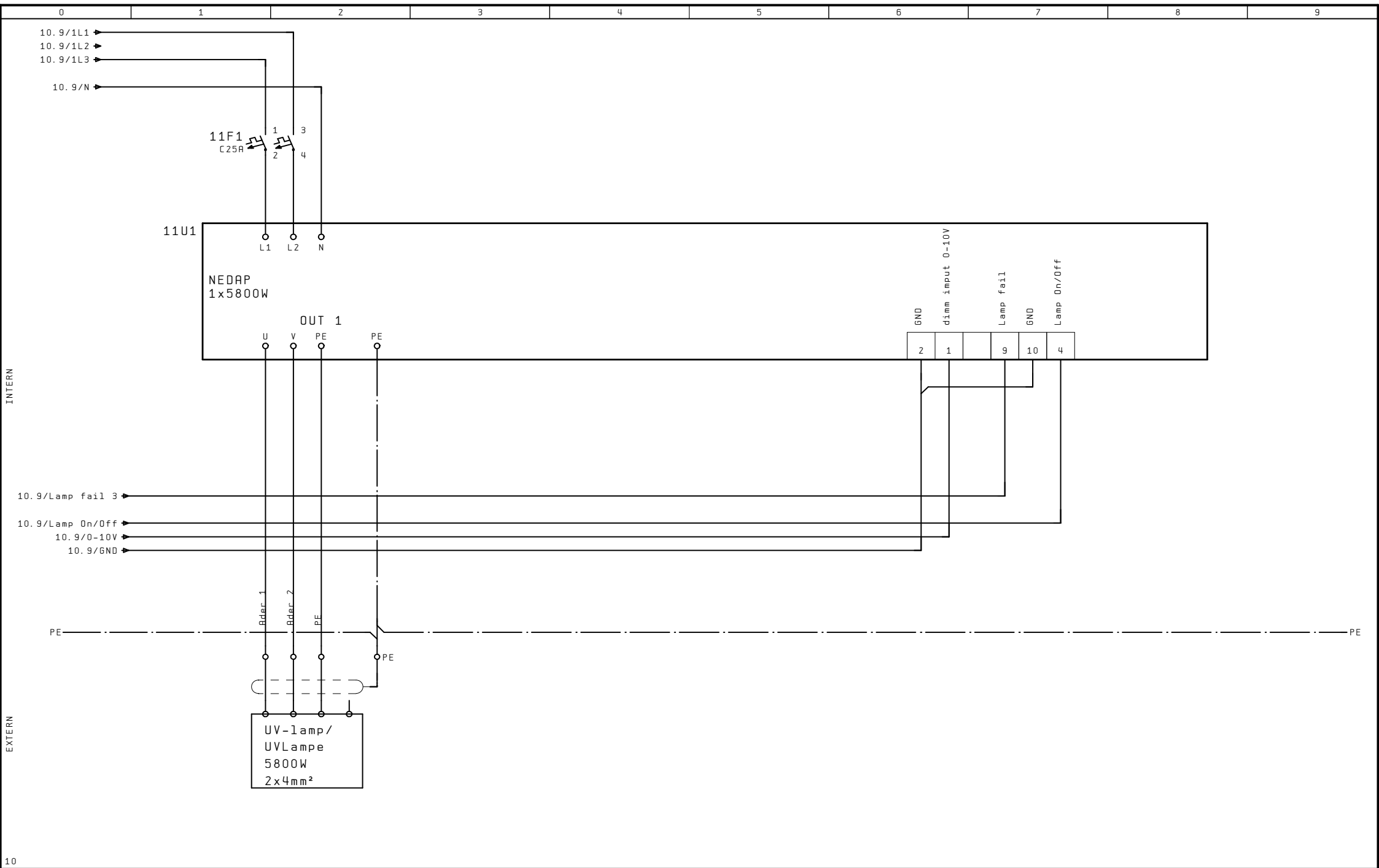

		Datum	07. Dez. 2018	T4500TCII Version 400V AC 800x1000x400		Ballast - UV-lamp / EVG - UV-Lampe		Version 13	=		
		Bearb.	ACA					3x5800W	+	s	11
		Gepr.	Höllner								
Änderung	Datum	Name		Urspr.	T4500_13	DATUM	19. Mär. 2013				